

FEATURES

- Fixed and Adjustable Versions Available
- Output Current in excess of 100mA
- Very Low Quiescent Current
- Reverse Battery Protection
- Input-output Differential less than 0.6V
- Short Circuit protection
- Internal Thermal Overload Protection
- 60V Load Dump Protection
- -50V Reverse Transient Protection
- Mirror Image Insertion Protection

APPLICATIONS

- Battery Powered Systems
- Portable Consumer Equipment
- Cordless Telephones
- Portable (Notebook) Computers
- Portable Instrumentation
- Radio Control Systems
- Automotive Electronics

GENERAL DESCRIPTION

The AMS2931 series consists of positive fixed and adjustable voltage regulators ideally suited for use in battery-powered systems. These devices feature very low quiescent current of 1mA or less when supplying 10mA loads. This unique characteristic and the extremely low input-output differential required for proper regulation (0.2V for output currents of 10mA) make the AMS2931 ideal to use for standby power systems.

Originally designed for automotive applications, the AMS2931 and all regulated circuitry are protected from input fault conditions caused by reverse battery installation or two battery jump starts. During line transients, such as load dump (60V) when the input voltage to the regulator can momentarily exceed the specified maximum operating voltage, the regulator will automatically shut down to protect both internal circuits and the load. The AMS2931 series also includes internal current limiting, thermal shutdown, and is able to withstand temporary power-up with mirror-image insertion.

The AMS2931 is offered in the 3-pin TO-92 package, 8-pin plastic SOIC, TO-220 and TO-263 packages.

ORDERING INFORMATION

OUTPUT VOLTAGE	PACKAGE TYPE				OPER. TEMP RANGE
	TO-92	8 LEAD SOIC	TO-220	TO-263	
FIXED*	AMS2931AN-X	AMS2931AS-X	AMS2931AT-X	AMS2931AM-X	-40°C to +85°C
	AMS2931N-X	AMS2931S-X	AMS2931T-X	AMS2931M-X	-40°C to +85°C
ADJ.		AMS2931CS			-40°C to +85°C

X = 2.0V, 2.5V, 3.0V, 3.3V, 3.5V, 4.0V, 5.0V

*For additional available fixed voltages contact factory

ABSOLUTE MAXIMUM RATINGS (Note 1)

Overvoltage Protection		
AMS2931A-X, AMS2931C		60V
AMS2931-X		50V
Maximum Input Voltage		22V
Internal Power Dissipation (Note 4)	Internally Limited	
Storage Temperature		-65°C to +150°C

OPERATING CONDITIONS (Note1)

Input voltage range	4V to 22V
Junction Temperature	+125°C
Lead Temperature (Soldering 25 sec)	265°C
ESD	2000V

ELECTRICAL CHARACTERISTICS

Electrical Characteristics at $V_{IN}=14V$, $I_O=10mA$, $T_J=25^\circ C$, $C_2=100\mu F$ unless otherwise specified.

PARAMETER	CONDITIONS	AMS2931A-X			AMS2931-X			Units
		Min.	Typ.	Max.	Min.	Typ.	Max.	
Fixed Output voltage Versions								
Output Voltage		-1.0		+1.0	-3.0		+3.0	%
	$6V \leq V_{IN} \leq 26V$, $I_O=100mA$ $-40^\circ C \leq T_J \leq 125^\circ C$	-3.0		+3.0		± 5.0		%
Line Regulation	$9V \leq V_{IN} \leq 16V$		2	10		2	10	mV
	$6V \leq V_{IN} \leq 26V$		4	30		4	30	mV
Load Regulation	$5mA \leq I_O \leq 100mA$		14	50		14	50	mV
Dropout Voltage	$I_O = 10mA$		50	200		50	200	mV
	$I_O = 100mA$		300	600		300	600	mV
Quiescent Current	$I_O \leq 10mA$, $6V \leq V_{IN} \leq 26V$ $-40^\circ C \leq T_J \leq 125^\circ C$		0.4	1.0		0.4	1.0	mA
	$I_O = 100mA$, $V_{IN} = 14V$, $T_J = 25^\circ C$	5	15	30		15		mA
Output Noise Voltage	10Hz-100kHz, $C_{OUT} = 100\mu A$		500			500		μV rms
Output Impedance	100mA _{DC} and 10mA _{rms} , 100Hz=10kHz			200			200	m Ω
Long Term Stability	T = 1000hr		20			20		mV
Ripple Rejection	$f_o = 120Hz$	55	80			80		dB
Maximum Line Transient	$R_L = 500\Omega$, $V_O \leq 5.5V$ T = 1ms, $\tau \leq 100ms$	60	70		50	70		V
Reverse Polarity Input Voltage, D/C		-15	-30		-15	-30		V
Reverse Polarity Input Voltage, Transient	$R_L = 500\Omega$, T = 1ms, $\tau \leq 100ms$	-50	-80		-50	-80		V

ELECTRICAL CHARACTERISTICS

Electrical Characteristics at $V_{IN}=14V$, $V_{OUT}=3V$ $I_O=10mA$, $T_J=25^\circ C$, $R_1=27k$, $C_2=100\mu F$ unless otherwise specified.

PARAMETER	CONDITIONS (Note 2)	Min.	AMS2931C Typ.	Max.	Units
Adjustable Version					
Reference Voltage		1.14	1.20	1.26	V
	$I_O \leq 100 \text{ mA}$, $-40^\circ C \leq T_J \leq 125^\circ C$, $R_1=27k$, Measured from V_{OUT} to Adjust Pin	1.08		1.32	V
Output Voltage Range		3	24		V
Line Regulation	$V_{OUT} + 0.6V \leq V_{IN} \leq 26V$.02	1.5	mV/V
Load Regulation	$5mA \leq I_O \leq 100 \text{ mA}$		0.3	1	%
Dropout Voltage	$I_O \leq 10 \text{ mA}$		0.05	0.2	V
	$I_O = 100 \text{ mA}$		0.3	0.6	V
Quiescent Current	$I_O = 10 \text{ mA}$		0.4	1	mA
	$I_O = 100 \text{ mA}$		15		mA
	During Shutdown $R_L = 500\Omega$		0.8	1	mA
Output Noise Voltage	10Hz-100kHz		100		$\mu V_{rms}/V$
Output Impedance	100mA _{DC} and 10mA _{rms} , 100Hz=10kHz		40		m Ω
Long Term Stability	T = 1000hr		0.4		%/1000hr
Ripple Rejection	$f_O = 120\text{Hz}$		0.02		%/V
Maximum Operating Input Voltage			21	22	V
Maximum Line Transient	$I_O = 10\text{mA}$, Reference Voltage $\leq 1.5V$ T = 1ms, $\tau \leq 100\text{ms}$	60	70		V
Reverse Polarity Input Voltage, D/C	$R_L = 500\Omega$, $V_O \geq -0.3V$	-15	-30		V
Reverse Polarity Input Voltage, Transient	$R_L = 500\Omega$, T = 1ms, $\tau \leq 100\text{ms}$	-50	-80		V
On/Off Threshold Voltage	$V_O = 3V$				
		On		2.0	1.2
Off		3.25	2.2		V
On/Off Threshold Current			20	50	μA

Note 1: Absolute Maximum Ratings are limits beyond which damage to the device may occur. For guaranteed performance limits and associated test conditions, see the Electrical Characteristics tables.

Note 2: See Circuit in Typical Applications. To ensure constant junction temperature, low duty cycle pulse testing is used.

Note 3: Limits appearing in **boldface** type apply over the entire junction temperature range for operation. Limits appearing in normal type apply for $T_A = T_J = 25^\circ C$.

Note 4: The junction-to-ambient thermal resistance are as follows: $195^\circ C/W$ for the TO-92 (N) package, $160^\circ C/W$ for the molded plastic SO-8 (S), $50^\circ C/W$ for the TO-220 package and $73^\circ C/W$ for the TO-263 package. If the TO-220 package is used with a heat sink, θ_{JA} is the sum of the package thermal resistance junction-to-case of $3^\circ C/W$ and the thermal resistance added by the heat sink and the thermal interface. The thermal resistance of the TO-263 package can be reduced by increasing the PCB copper area thermally connected to the package: using 0.5 square inches of copper area, ϕ_{JA} is $50^\circ C/W$; with 1 square inch of copper area ϕ_{JA} is $37^\circ C/W$; and with 1.6 or more square inches of copper area ϕ_{JA} is $32^\circ C/W$.

PIN CONNECTIONS

FIXED OUTPUT VOLTAGE

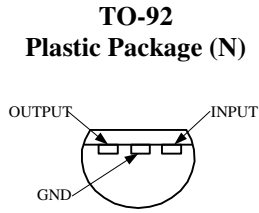

Bottom View

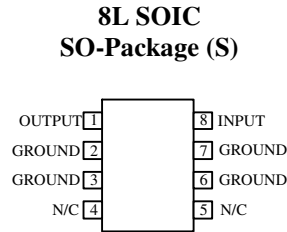

Top View

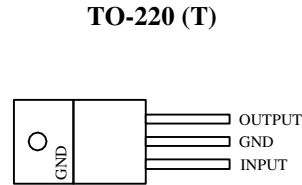

Front View

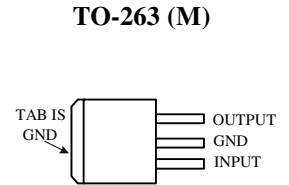

Top View

ADJUSTABLE OUTPUT VOLTAGE

**8L SOIC
SO-Package (S)**

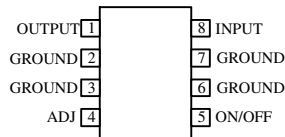

Top View

TYPICAL APPLICATIONS

AMS2931-X (Fixed Output)

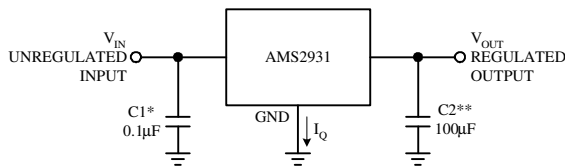

*Required if regulator is located far from power supply filter.
 **C2 must be at least 100µF to maintain stability; it can be increased without bound to maintain regulation during transients and it should be located as close as possible to the regulator. This capacitor must be rated over the same operating temperature range like the regulator. The ESR of this capacitor is critical (see curve).

AMS2931C (Adjustable Output)

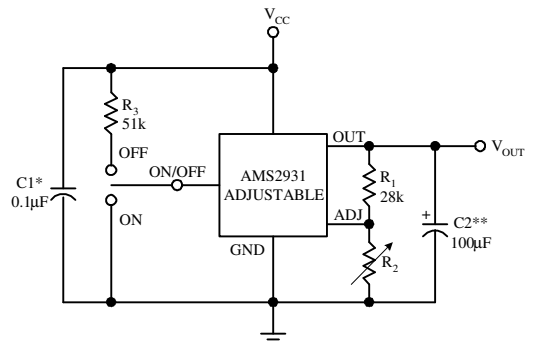

$$V_{OUT} = V_{REF} \times (R_1 + R_2) / R_1$$

Note: Using 27k for R1 will automatically compensate for errors in V_{OUT} due to the input bias current of the Adjust Pin (approx. 1µA)

TYPICAL PERFORMANCE CHARACTERISTICS

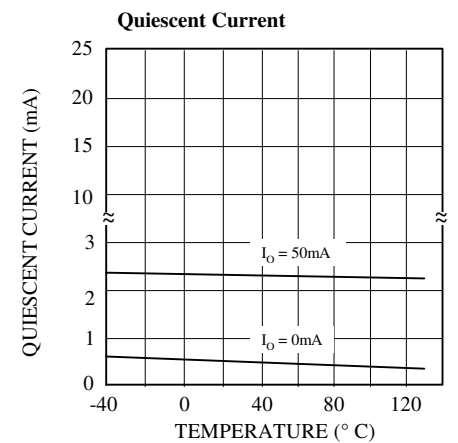
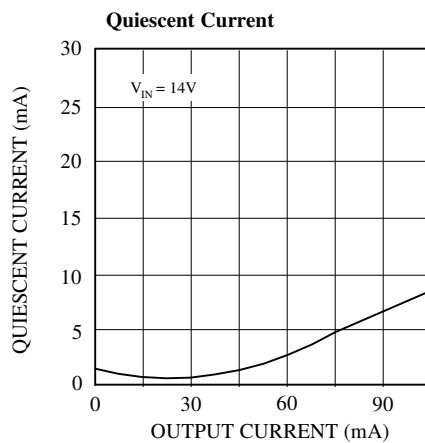
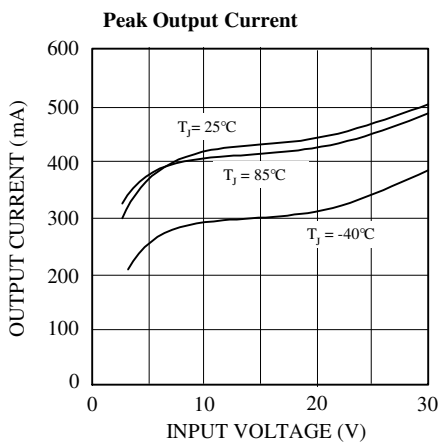
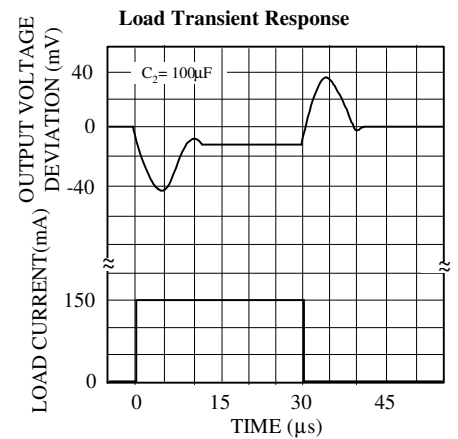
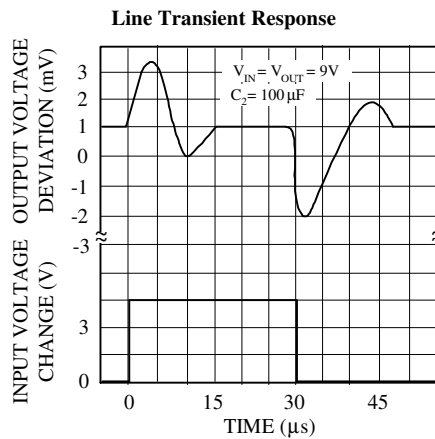
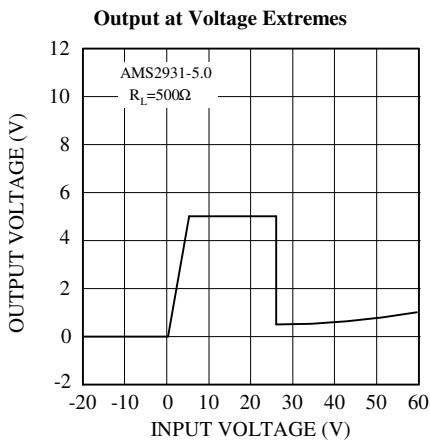
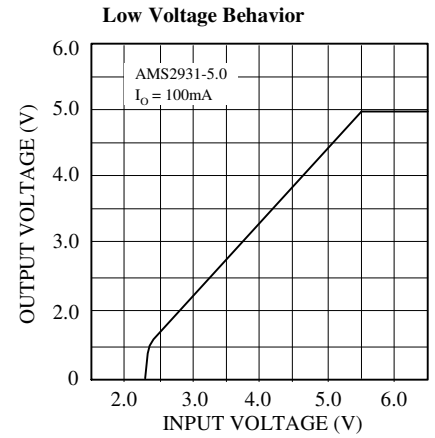
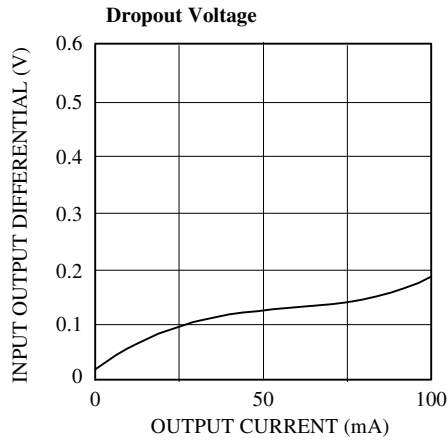
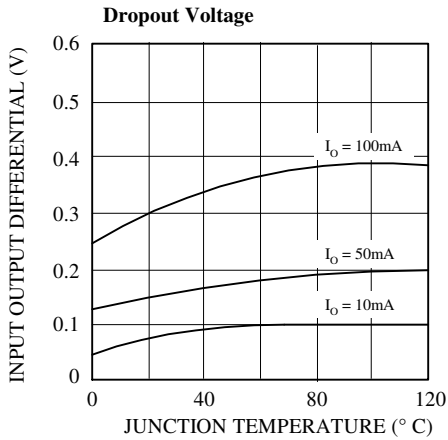

TYPICAL PERFORMANCE CHARACTERISTICS (Continued)

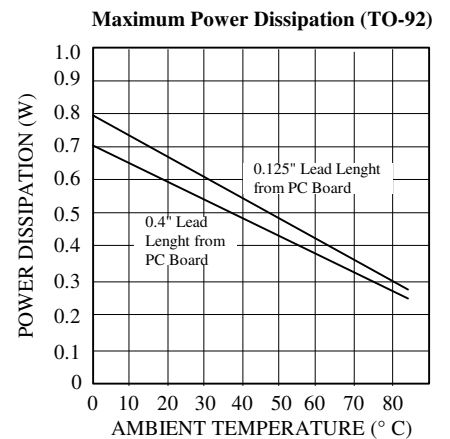
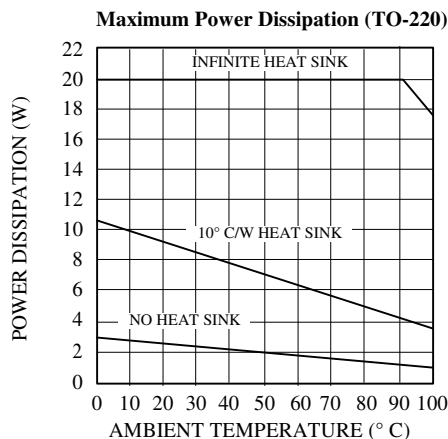
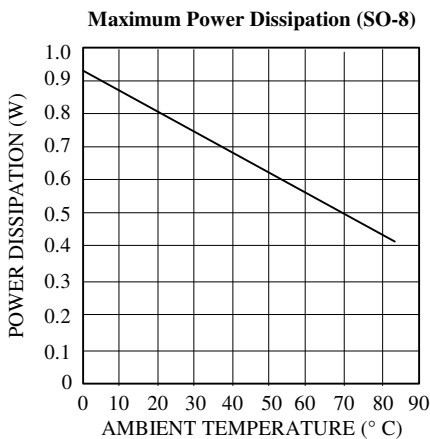
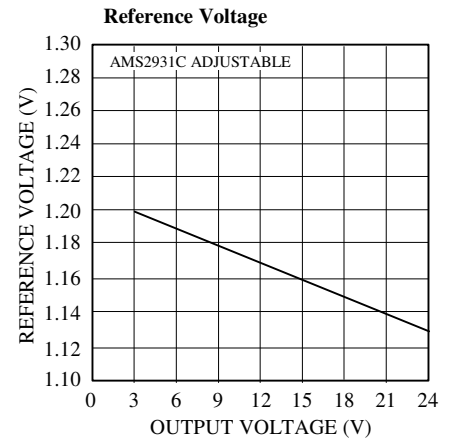
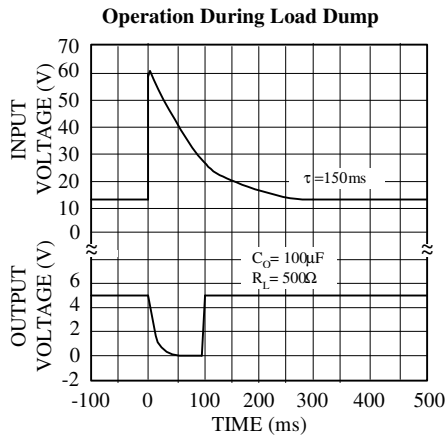
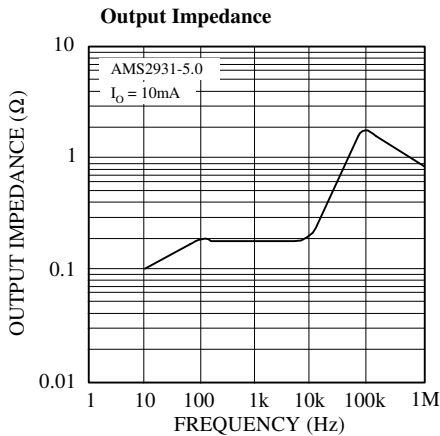
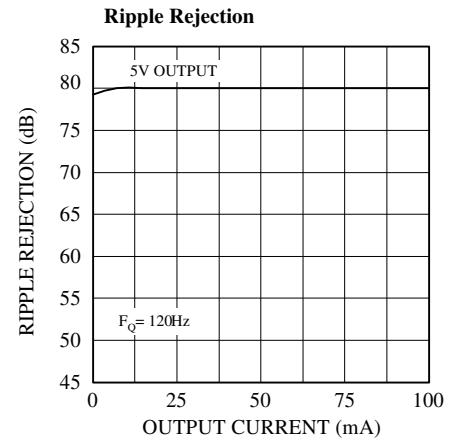
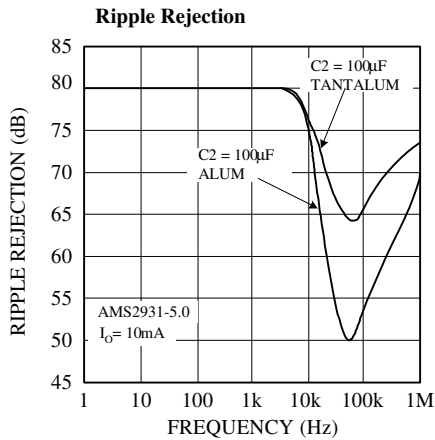
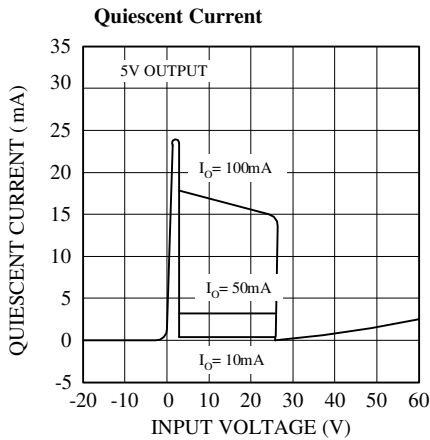

TYPICAL PERFORMANCE CHARACTERISTICS (Continued)

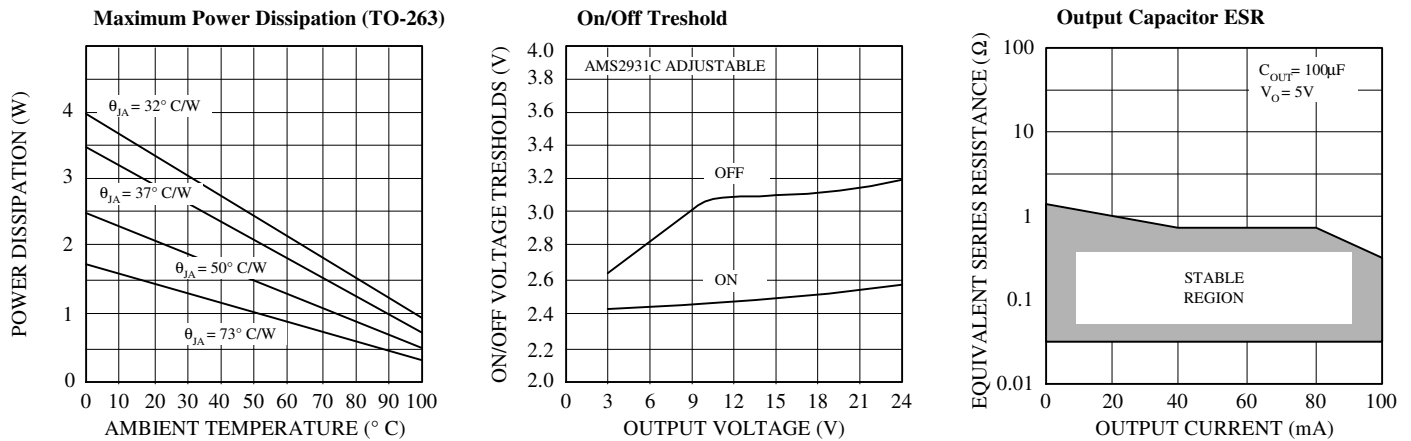

APPLICATION HINTS

The AMS2931 series require an output capacitor for device stability. The value required depends on the application circuit and other factors.

Because high frequency characteristics of electrolytic capacitors depend greatly on the type and even the manufacturer, the value of capacitance that works well with AMS2931 for one brand or type may not necessary be sufficient with an electrolytic of different origin. Sometimes actual bench testing will be the only means to determine the proper capacitor type and value. To obtain stability in all general applications a high quality 100 μF aluminum electrolytic or a 47 μF tantalum electrolytic can be used.

A critical characteristic of the electrolytic capacitors is their performance over temperature. The AMS2931 is designed to operate to -40°C, but some electrolytics will freeze around -30°C therefore becoming ineffective. In such case the result is oscillation at the regulator output. For all application circuits where cold operation is necessary, the output capacitor must be rated to operate at the minimum temperature. In applications where the regulator junction temperature will never be lower than 25°C the output capacitor value can be reduced by a factor of two over the value required for the entire temperature range (47 μF for a high quality aluminum or 22 μF for a tantalum electrolytic capacitor).

With higher output currents, the stability of AMS2931 decreases. Considering the fact that in many applications the AMS2931 is operated at only a few milliamps (or less) of output current, the output capacitor value can be reduced even further. For example, a circuit that is required to deliver a maximum of 10mA of output current from the regulator output will need an output capacitor of only half the value compared to the same regulator required to deliver the full output current of 100mA.

In the case of AMS2931C (adjustable), the minimum value of output capacitance is a function of the output voltage. As a general rule, with higher output voltages the value of the output capacitance decreases, since the internal loop gain is reduced.

In order to determine the minimum value of the output capacitor, for an application circuit, the entire circuit including the capacitor should be bench tested at minimum operating temperatures and maximum operating currents. To maintain internal power dissipation and die heating to a minimum, the input voltage should be maintain at 0.6V above the output. Worst-case occurs just after input power is applied and before the die had the chance to heat up. After the minimum capacitance value has been found for the specific brand and type of electrolytic capacitor, the value should be doubled for actual use to cover for production variations both in the regulator and the capacitor.

PACKAGE DIMENSIONS inches (millimeters) unless otherwise noted.

3 LEAD TO-92 PLASTIC PACKAGE (N)

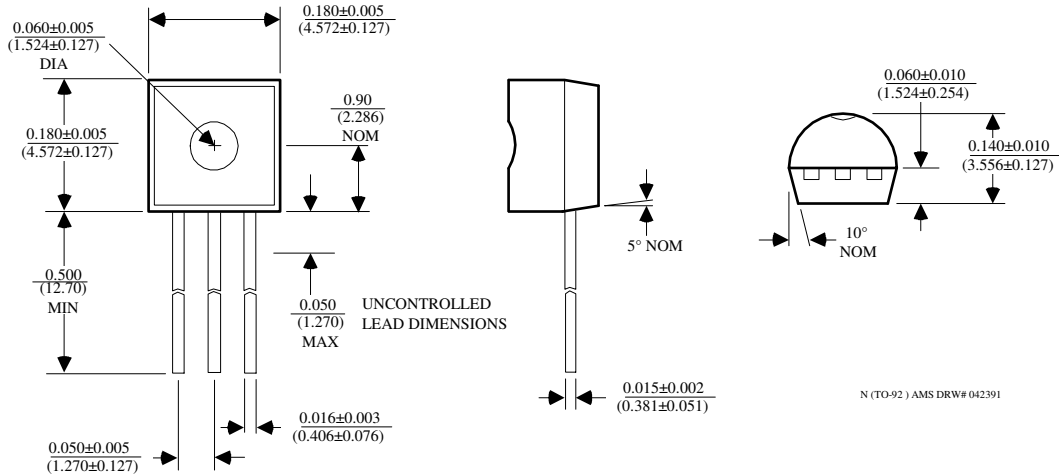

8 LEAD SOIC PLASTIC PACKAGE (S)

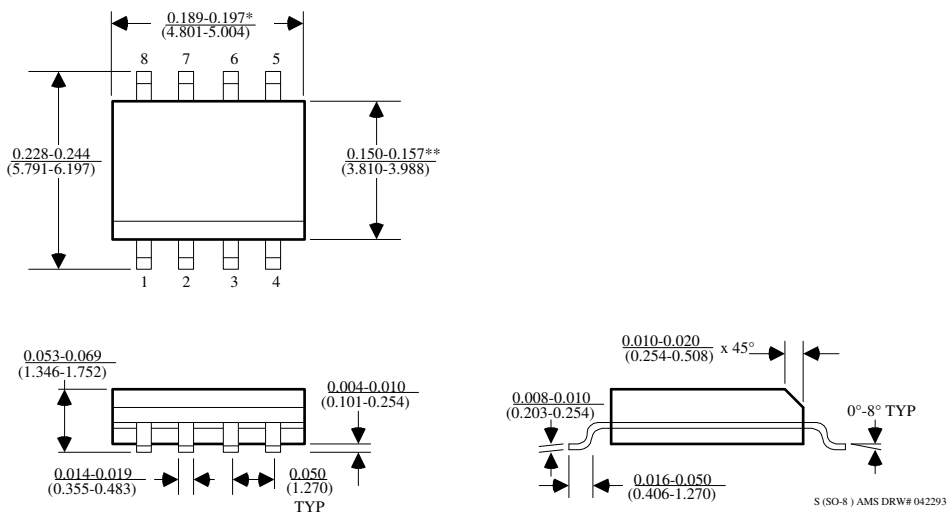

*DIMENSION DOES NOT INCLUDE MOLD FLASH. MOLD FLASH SHALL NOT EXCEED 0.006" (0.152mm) PER SIDE

**DIMENSION DOES NOT INCLUDE INTERLEAD FLASH. INTERLEAD FLASH SHALL NOT EXCEED 0.010" (0.254mm) PER SIDE

PACKAGE DIMENSIONS inches (millimeters) unless otherwise noted (Continued).

3 LEAD TO-220 PLASTIC PACKAGE (T)

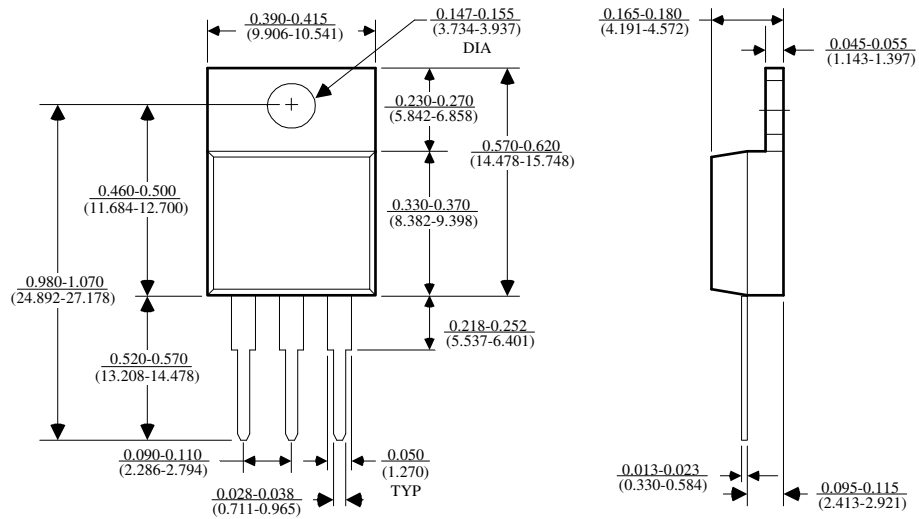

T (TO-220) AMS DRW# 042193

3 LEAD TO-263 PLASTIC DD (M)

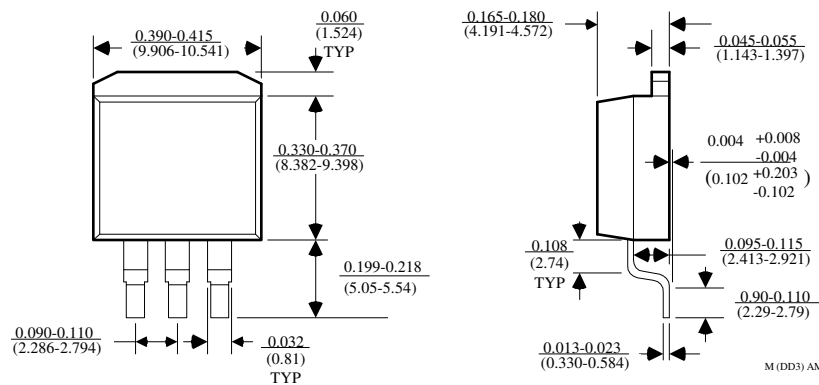

M (DD3) AMS DRW# 042191R1